



Product Summary

$V_{(BR)DSS}$	$R_{DS(on)TYP}$	I_D
120V	3.8m Ω @10V	180A

Feature

- Split Gate Trench Technology
- Low $R_{DS(ON)}$
- Low Gate Charge
- Low Gate Resistance
- 100% UIS Tested

Application

- Power Switching Application

MARKING:

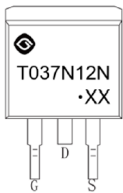

T037N12N = Device Code
XX = Date Code
Solid Dot = Green Indicator

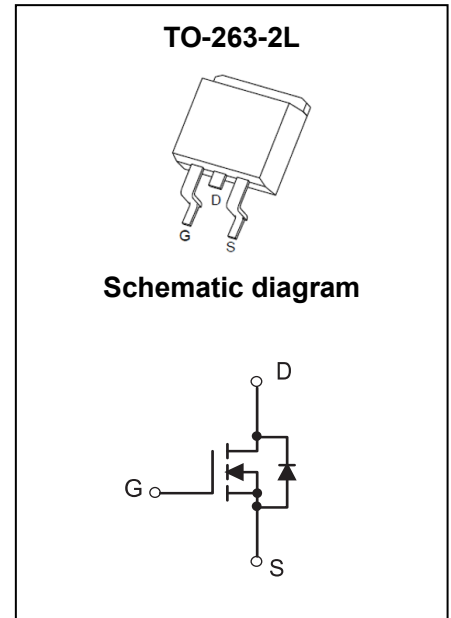

ABSOLUTE MAXIMUM RATINGS ($T_A = 25^\circ\text{C}$ unless otherwise noted)

Parameter	Symbol	Value	Unit
Drain - Source Voltage	V_{DS}	120	V
Gate - Source Voltage	V_{GS}	± 20	V
Continuous Drain Current ^{1,5}	I_D	$T_C = 25^\circ\text{C}$	180
		$T_C = 100^\circ\text{C}$	117
Pulsed Drain Current ²	I_{DM}	720	A
Single Pulsed Avalanche Current ³	I_{AS}	53	A
Single Pulsed Avalanche Energy ³	E_{AS}	650	mJ
Power Dissipation ^{4,5}	P_D	215	W
Thermal Resistance from Junction to Ambient ⁶	$R_{\theta JA}$	45	$^\circ\text{C}/\text{W}$
Thermal Resistance from Junction to Case	$R_{\theta JC}$	0.58	$^\circ\text{C}/\text{W}$
Junction Temperature	T_J	150	$^\circ\text{C}$
Storage Temperature	T_{STG}	-55~ +150	$^\circ\text{C}$

MOSFET ELECTRICAL CHARACTERISTICS ($T_A = 25^\circ\text{C}$ unless otherwise noted)

Parameter	Symbol	Test Condition	Min	Type	Max	Unit
Off Characteristics						
Drain - Source Breakdown Voltage	$V_{(BR)DSS}$	$V_{GS} = 0V, I_D = 250\mu A$	120			V
Zero Gate Voltage Drain Current	I_{DSS}	$V_{DS} = 120V, V_{GS} = 0V$			1	μA
Gate - Body Leakage Current	I_{GSS}	$V_{GS} = \pm 20V, V_{DS} = 0V$			± 100	nA
On Characteristics³						
Gate Threshold Voltage	$V_{GS(th)}$	$V_{DS} = V_{GS}, I_D = 250\mu A$	2.0	3.2	4.0	V
Drain-source On-resistance	$R_{DS(on)}$	$V_{GS} = 10V, I_D = 20A$		3.8	5.0	m Ω
Dynamic Characteristics						
Input Capacitance	C_{iss}	$V_{DS} = 60V, V_{GS} = 0V, f = 0.1\text{MHz}$		4751		pF
Output Capacitance	C_{oss}			962		
Reverse Transfer Capacitance	C_{rss}			32		
Gate Resistance	R_g	$V_{DS} = 0V, V_{GS} = 0V, f = 1\text{MHz}$		2.7		Ω
Switching Characteristics						
Total Gate Charge	Q_g	$V_{DS} = 15V, V_{GS} = 10V, I_D = 20A$		73.5		nC
Gate-source Charge	Q_{gs}			21.7		
Gate-drain Charge	Q_{gd}			18.4		
Turn-on Delay Time	$t_{d(on)}$	$V_{DD} = 60V, V_{GS} = 10V, I_D = 75A,$ $R_G = 4.7\Omega$		25		ns
Turn-on Rise Time	t_r			80		
Turn-off Delay Time	$t_{d(off)}$			50		
Turn-off Fall Time	t_f			15		
Source - Drain Diode Characteristics						
Diode Forward Voltage ³	V_{SD}	$V_{GS} = 0V, I_S = 20A$			1.2	V

Notes :

- 1.The maximum current rating is limited by package.And device mounted on a large heatsink
- 2.Pulse Test : Pulse Width $\leq 10\mu s$, duty cycle $\leq 1\%$.
- 3.EAS condition: $V_{DD} = 60V, V_{GS} = 10V, L = 0.5\text{mH}, R_G = 25\Omega$ Starting $T_J = 25^\circ\text{C}$.
- 4.Pulse Test : Pulse Width $\leq 300\mu s$, duty cycle $\leq 2\%$.
- 5.The power dissipation P_D is limited by $T_{J(MAX)} = 150^\circ\text{C}$.And device mounted on a large heatsink
- 6.Device mounted on 1in^2 FR-4 board with 2oz. Copper, in a still air environment with $T_A = 25^\circ\text{C}$.

Typical Characteristics

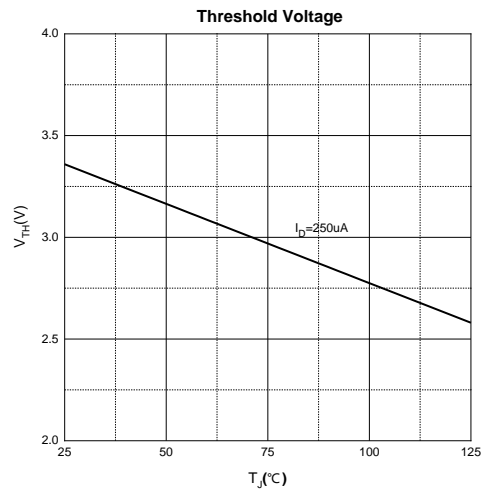
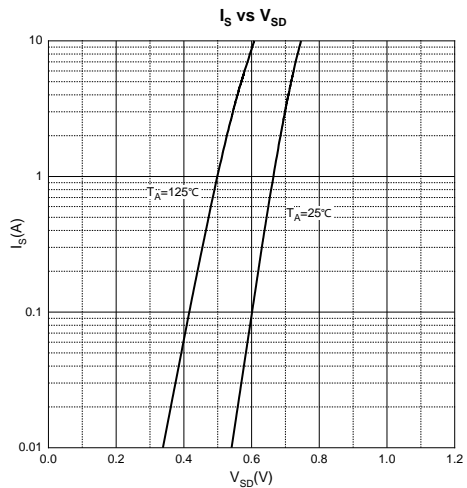
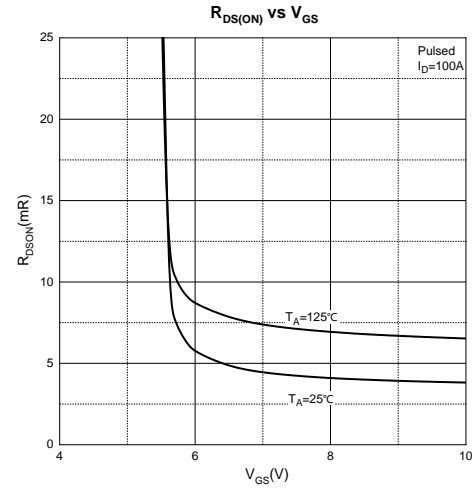
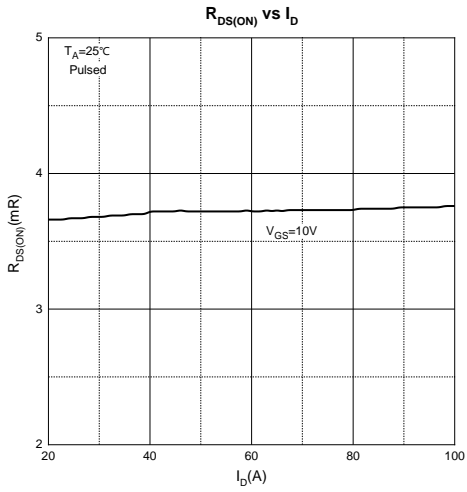
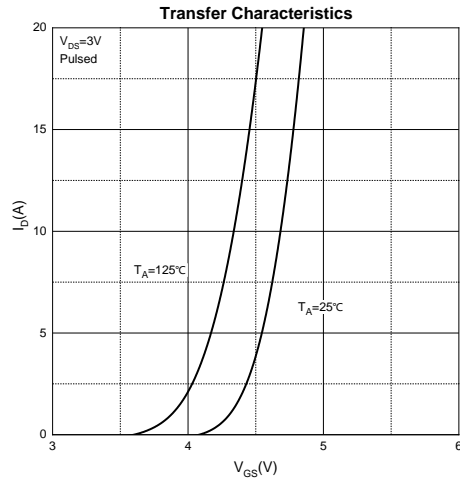
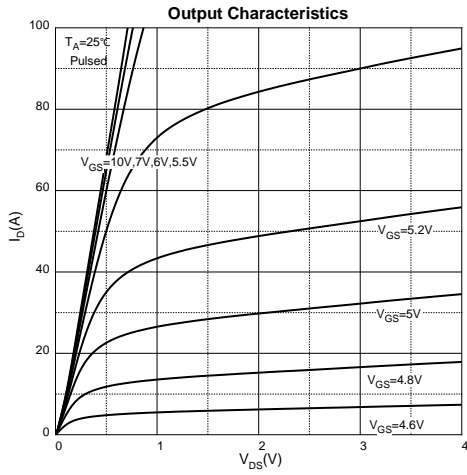

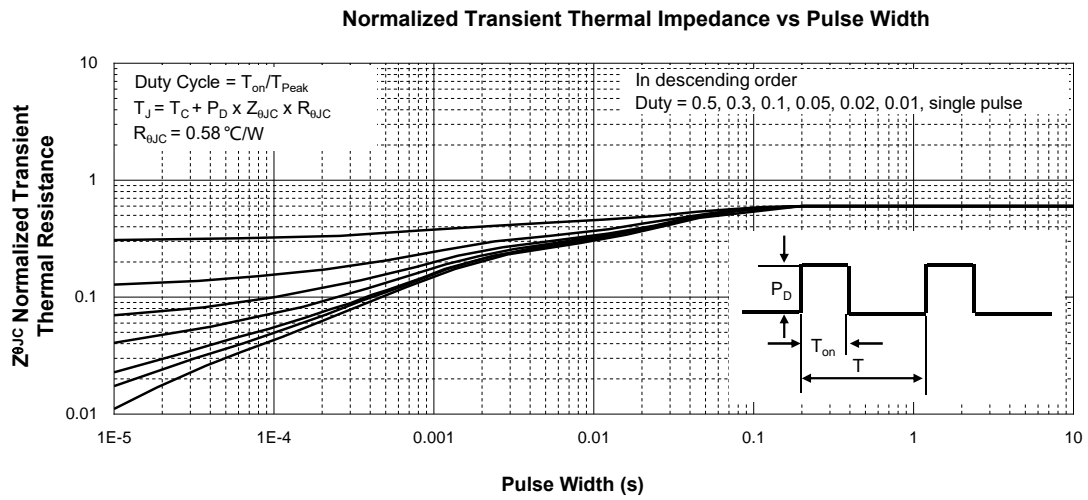
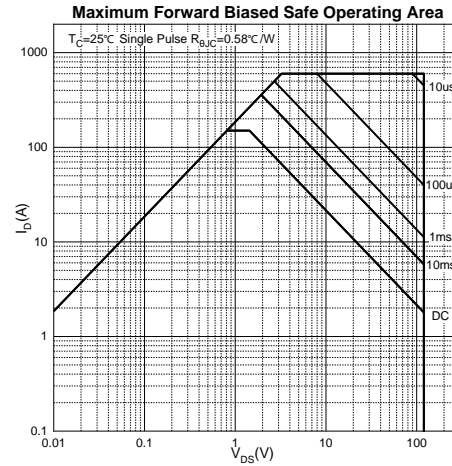
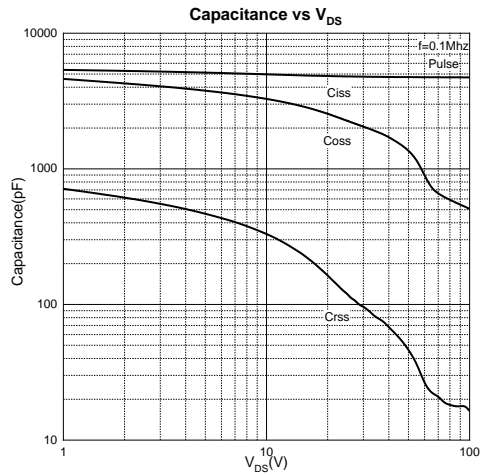

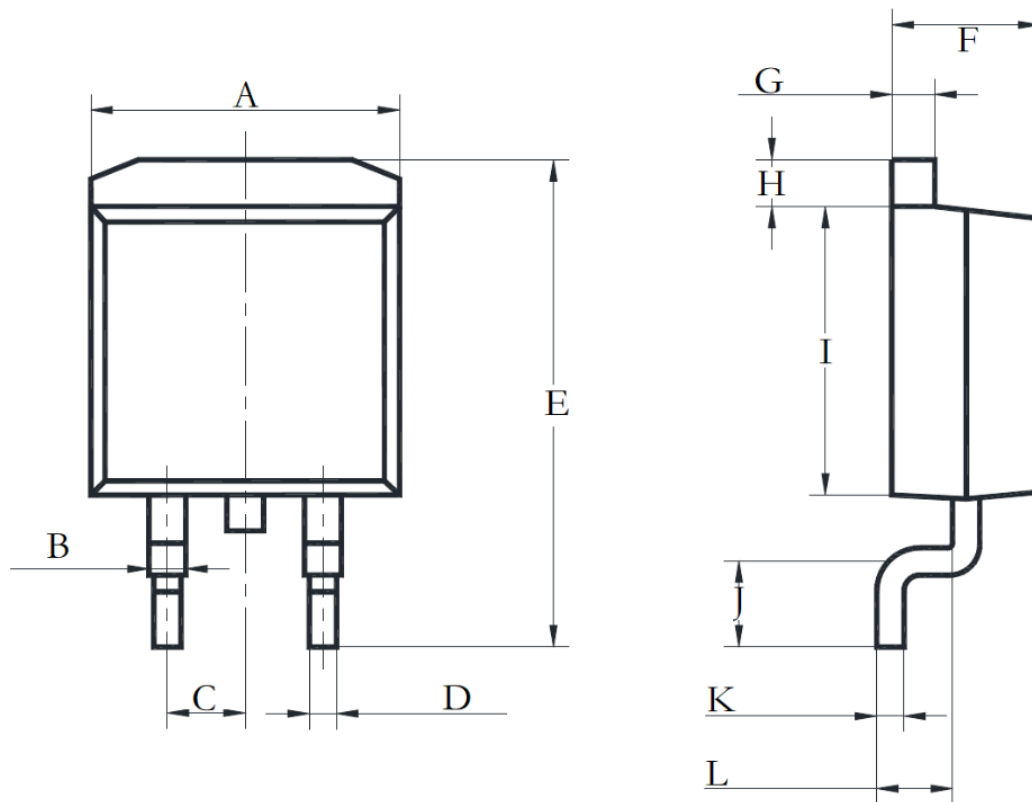
TO-263-2L Package Information

Symbol	Dimensions In Millimeters		Dimensions In Inches	
	Min.	Max.	Min.	Max.
A	9.600	10.500	0.378	0.413
B	1.000	1.400	0.039	0.055
C	2.540REF		0.100REF	
D	0.680	0.940	0.027	0.037
E	14.600	15.880	0.575	0.625
F	4.400	4.800	0.173	0.189
G	1.140	1.400	0.045	0.055
H	1.140	1.400	0.045	0.055
I	8.250	9.650	0.325	0.380
J	2.290	2.790	0.090	0.110
K	0.360	0.650	0.014	0.026
L	2.030	2.790	0.080	0.110